

# VCS/VCFS

Prevent future leaks and blowouts

# GPT

an EnPro Industries company

INNOVATIVE ENGINEERING FOR CORROSION PROTECTION



For Zero Fugitive Emissions  
& Extreme Critical Sealing Applications

The VCS/VCFS systems use proprietary materials to address the regulations associated with fugitive emissions requirements that are closely monitored and highly sensitive to regulatory agencies today.



# VCS Sealing & Isolation

## FEATURES

- » Extreme, high-reliability sealing and electrical isolation solution for critical service applications
- » Seals and isolates all pressure ratings through ANSI 2500 class and API 10,000 psi service
- » Withstands severe service conditions including vibration, temperature and pressure fluctuations
- » Designed to withstand corrosive environments, including high concentrations of CO<sub>2</sub>, H<sub>2</sub>S, produced water and aggressive inhibitors
- » Good electrical isolation properties for cathodic protection
- » Pressure-activated seals provide high confidence sealing, eliminates costly leaks and provides a solution for fugitive emissions
- » Gasket is sized to the bore to protect flange faces from media-induced corrosion and flow-induced erosion
- » Prevents turbulent flow at flanged connections
- » Mitigates galvanic corrosion in dissimilar metal flanges
- » High-strength laminate material resists failure due to excessive compression
- » Available to match any flange specification (ANSI, ASME, API, MSS, BS, DIN, AS, others)
- » Can mate mismatched RTJ with raised-face flanges
- » Easy installation, make up and removal
- » Sealing system is not sensitive to low bolt loads - providing reliable sealing through a range of bolt stress
- » Gasket is self-aligning and centering - quick to install and no special tools are required
- » Maintenance-free corrosion-resistant design is resistant to deforming under load
- » Works in Ring Joint Flanges, reducing fluid entrapment, flow induced erosion and media induced corrosion between flanges
- » Reusable by simply replacing sealing ring

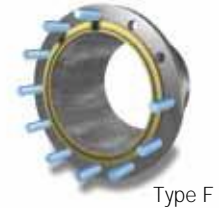
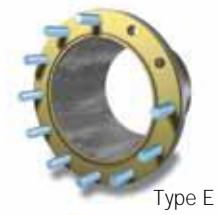

Sealing element may be positioned anywhere between the I.D. of the gasket and I.D. of the bolt circle depending on flange design.

**NOTE:** Can be custom made to order

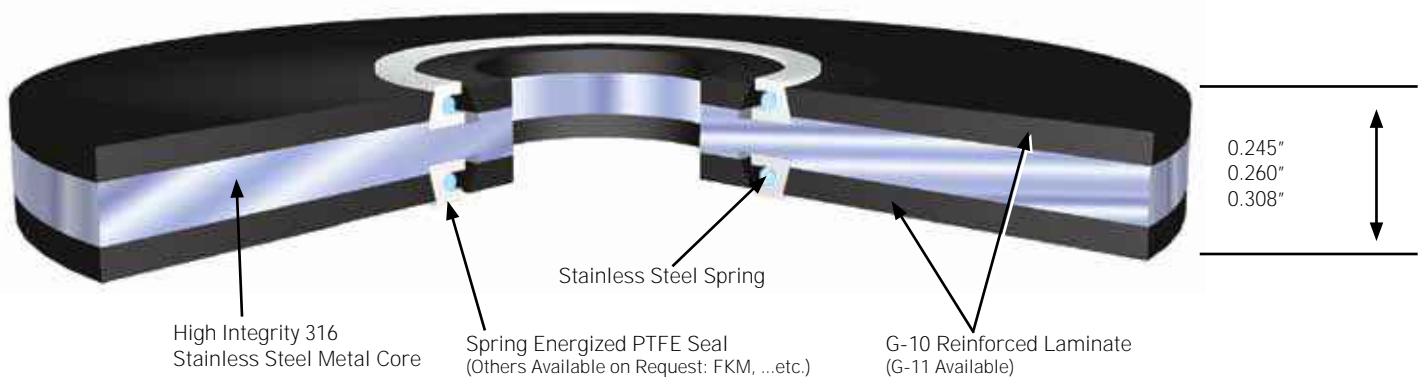

## APPLICATIONS

- » H<sub>2</sub>S Service
- » High pressure flanges
- » Critical service applications
- » High pH Service
- » Locations where one prefers an integral seal element
- » A more convenient spiral-wound type gasket replacement

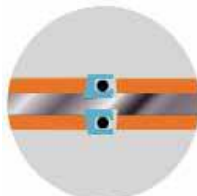

### Before Tightening

The flange faces come into contact with the sealing elements, which extend slightly above the surface of the retainer. As the flange is tightened the sealing elements are compressed into the machine groove, developing an initial high unit pressure against the flange faces.

**NOTE:** Can work for ring joint flanges reducing fluid entrapment.

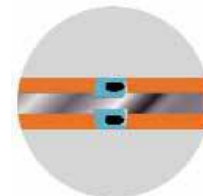

### After Tightening

The flange faces come into firm contact with the retainer, thus compacting the sealing elements within grooves. At the same time, the unique VCS spring energized seal provides elastic memory for a polymer not normally associated with this characteristic - resulting in a simple flat gasket with extremely high loading and self energizing characteristics without adverse cold flow problems.

# VCFS Firesafe Isolation

## VCFS FIRESAFE

- » Based upon proven GPT VCS platform
- » Provides complete flange electrical isolation
- » Tandem seal technology
- » PTFE sealing system has 20+ years successful track record
- » E-Ring sealing systems is dual purpose fire safe and backup
- » Passed API 6FB, 3rd Edition Fire Test
- » Use in conjunction with cathodic protection systems
- » Mitigates potential flange rotation
- » Provides a tighter seal under low bolt loads

## INTRODUCTION

The creation of the VCFS was driven by the demands of our customers who needed to electrically isolate their flanges but worried about the performance of non-metallic components in the event of a fire. This was especially a concern in the offshore market where the consequences of a fire on platforms are very hazardous and costly.

Additionally, the needs of users in piping and LNG applications, where the risk of a fire would greatly threaten life and property, drove the need for an electrical isolation seal that is fire safe per API 6FB.

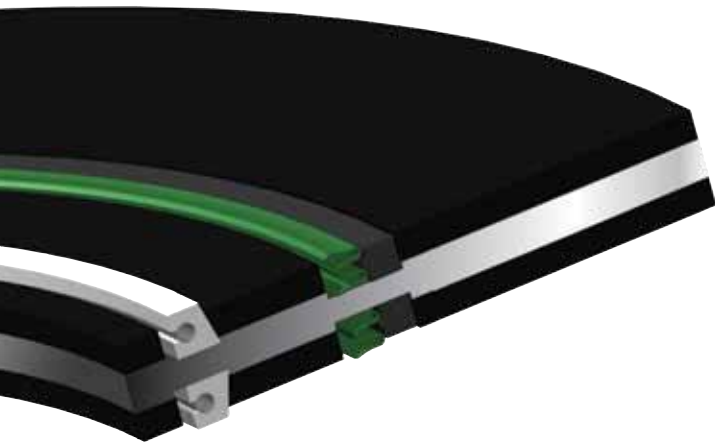

Before Fire

## DEVELOPMENT

Development of the patented VCFS took over three years in overcoming the many challenges involved. One major challenge was how to maintain bolt load during the event of a fire. This involved addressing the sealing mechanism itself as well as the isolating washers.

Extensive testing led to the use of a hardened Inconel E-ring to perform the secondary sealing after the PTFE seal had been melted by the fire. However, the E-ring compression was quite critical, and had to be mitigated to prevent excessive compression during the burn. This led to use of the back-up ring to precisely manage E-ring compression.

Another problem was that as metallic elements, neither the E-ring nor the back-up ring provided the required isolation properties. The solution was to employ a dielectric coating that would isolate and withstand compression of the flanges.

The result was the formulation of the proprietary X37 coating which performed admirably during testing and provided isolation even after three bolt-up operations to full torque levels.

The next challenge came due to the fact that standard G-10 Glass Reinforced Epoxy (GRE) washers degraded in a fire and lost bolt load, which resulted in the release of media in a fire. This led to the development of tandem Hardened Coated Steel washers that electrically isolate, yet retain bolt load in a fire.

The combination of these elements created a system that would both electrically isolate the flanges and pass the API 6FB Fire Test.

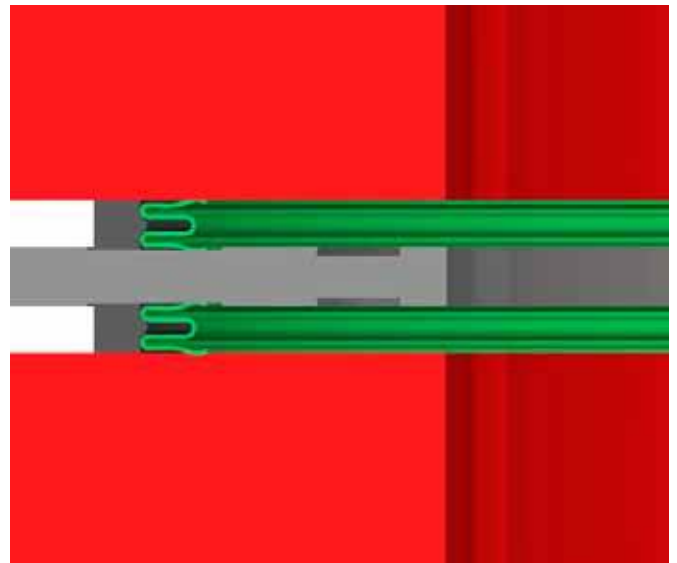

After Fire

# VCFS Firesafe Isolation

## API 6FB FIRE TEST

The API 6FB test requires that any sealing end connection hold for 30 minutes in a flame condition and then for a 60 minute cool down period. After the assembly is cooled to room temperature the line is de-pressurized and then re-pressurized. During all facets of the test the gasket must not exceed an API prescribed leakage rate.

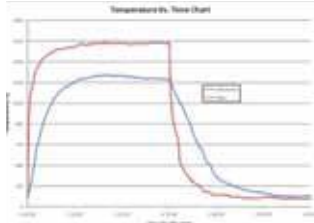

Chart 1: Temperature logging for the calorimeter blocks and thermocouples during the full 60 minute burn and cool down cycle.

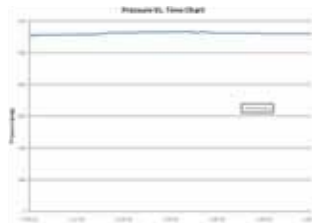

Chart 2: Pressure versus time curve for this test.

The testing assembly included 6" Class 300 VCFS kits complete with sleeves and HCS washers, 6" carbon steel flanged blinds with a 2" bore and 1" pipe welded to the outside of the flanges at the bore complete with 1" end caps. Studs and nuts for the flanges, Grade A193-B7 and 2H respectively and two high capacity propane burners, six thermocouples and six calorimeter blocks.

After the 1" pipe was welded to each of the steel flange blinds, end caps were threaded onto each pipe end. Ports were created in one of the end caps to accommodate the necessary pressure equipment. The GPT VCFS gasket was installed between the flanges and the flanged assembly was made up with a torque value of 200ft-lbs using the appropriate star pattern.

After the flange assembly was completed a Megger® isolation testing device (model MIT 481) was used to validate the gasket's isolation properties. This isolation tester was set to the highest setting of 1000V DC and the isolation between the flange-to-flange connections was measured. The isolation between the flanges and threaded stud connection was then measured using the same setting; four different isolation measurements were taken for this test at the 3, 6, 9, and 12 o'clock bolt positions.

The two large propane burners were then put into place according to API fire test protocol. These burners were ignited manually and were used to provide the flame for the thirty minute burn cycle. The flame was controlled by a valve at the central computer location; this valve was used to regulate the propane flow into the burners. Chart 1 contains the temperature logging for the calorimeter blocks and thermocouples during the full 60 minutes burn and cool down cycle.

The leakage that occurred during the 120 minute burn and cool down cycle was calculated using readings that were taken by a differential pressure transducer. Water that was

used for the testing media was stored in an 8 inch pipe with an inside diameter of 8.071 (20.5cm). Using basic volume calculations, volume loss per every inch (2.54cm) of water height was determined.

System pressure was another variable that was tracked during the API 6FB test. The protocol required that pressure be held constant during the 120 minute burn and cool down cycle. Since any water leakage in the system would result in an overall pressure loss, the pressure must be increased appropriately to maintain the average pressure specified by API 6Fb testing protocol. Chart 2 shows the pressure versus time curve for this test.

For sizes below 6" on RTJ flanges and 2" on raised face flanges GPT has designed the single seal Firesafe isolating kit. The single seal utilizes the technology of the E ring to provide the seal and the X37 coating and the GRE laminate continues to give full isolation properties that are prevalent in the traditional GPT VCS design.

The VCFS is also offered in a High Temperature design that utilizes G-11 Instead of G-10. This allows the seal to service higher operating temperatures up to 392°F.

65,000psi Compressive Strength gives the seal the ability to withstand the bolting and flange stresses

750-800 VPM Dielectric Strength shows that the kit has the capacity to meet the isolation demands

0.05% Water Absorption assures that the product will not suffer from the effects of ingress from media

50,000psi Tensile Strength gives the user the confidence that the seal has the ability to withstand the internal pressures

Most of the standard bolting lubricants are conductive so GPT developed a non conductive metal free grease called Piko-Lube in order to minimize the potential of resistance loss. GPT would recommend this lubricant for use on isolating systems and it has a friction factor of 0.15.

Unlike some suppliers GPT will not offer a product that does not conform to the highest technical standards. We are proud of our achievements in design and technology and will give the support and back up necessary to provide the most suitable products. In this regard GPT is unique in the industry.

**\* NOTE:** The "FS" or "Fire Safe" designation denotes only that this gasket has successfully passed the API 6FB fire test. Due to the fact that every fire is unique and many uncontrolled variables are present, no other claims regarding suitability or performance in a fire are made. Each designer, user and/or operator will need to assess their individual situation when deciding to install FS style gaskets. Patent Pending.





# VCS Material Properties

## COMMON VCS MATERIAL PHYSICAL PROPERTIES

ASTM	Test Method	G-10 Epoxy/ Glass	G-11 Exopy/ Glass
D149	Dielectric Strength Volts/ Mil (Short Time)	800	550
D695	Compressive Strength (psi)	65,000	58,000
D229	Water Absorption (%)	0.04	0.08
D257	Insulation Resistance Meg Ohms	300,000	225,000
D790	Flexural Strength (psi)	65,000	58,000
D256	IZOD Impact Strength (Ft- Lbs/Inch)	26.0	10.0
D638	Tensile Strength (psi)	51,000	41,000
D732	Shear Strength (psi)	21,000	21,000
	Temperature Range (°F)	-200 to 302	-50 to 392
	Temperature Range (°C)	-129 to 150	-46 to 200

**NOTE:** G-10 for cryogenic services to -459° F / -273° C is also available.

## VCS AND VCFS RECOMMENDED TORQUE VALUES

NPS	150#	300#	600#	900#	1500#	2500#
½	35	35	35	125	125	125
¾	35	71	71	125	125	125
1	35	71	71	202	202	202
1¼	35	71	71	202	202	303
1½	35	125	125	303	303	445
2	71	71	71	202	195	303
2½	71	125	125	303	303	445
3	71	125	125	202	445	625
3½	71	125	202	N/A	N/A	1119
4	71	125	202	445	625	1822
5	125	125	303	625	1119	2771
6	125	125	303	445	848	2771
8	125	202	445	848	1442	5553
10	202	303	625	848	2263	7260
12	202	445	625	848	2771	N/A
14	303	445	848	1119	4002	N/A
16	303	625	1119	1442	5553	N/A
18	445	625	1442	2263	7460	N/A
20	445	625	1442	2771	9759	N/A
22	625	1119	1822	N/A	N/A	N/A
24	625	1119	2263	5553	15686	N/A

**NOTE:** This torque chart is for B16.5 flanges only. The recommended max value is 30,000psi. Please verify that your preferred % of yield is not exceeded with these values. The values above are for temperatures at or below the gasket rated temperature.

## VCS TEST RESULTS - TYPICAL

Test	VCS Value
Compression Test EN 13555 @ 150° C	140 Mpa Gasket Stress
Creep Relaxation EN 13555 @ 150° C	0.99 Relaxation Factor
Leakage Test EN 13555 @ 40 bar Helium @ 5 Mpa to 80 Mpa gasket stress	1.0 x 10 <sup>-3</sup> mg/m/s Leakage rate
Hot Blowout Test HOBT @ 151° C @ 165 bar	No Blowout
Shell Leakage Test T-2.232686 @ ambient @ 52 Mpa	4.2 x 10 <sup>-7</sup> pa-m <sup>3</sup> /s/mm Leakage Rate
Shell Cycle Test T-2.232686 @ 150° C @ 45.6 Mpa	< 0.10 bar pressure loss

## ELEMENT TEMPERATURE LIMITS

	PTFE	FKM
Degrees Fahrenheit	Cryogenic to + 450	-20 to +350
Degrees Celsius	Cryogenic to +232	-29 to +177

**NOTE:** Consult with a specialist for cryogenic applications and/or extreme temperature variations, hazardous fluids or for extremes in temperatures and pressures.

# VCS Flange Isolation Kits

## DOUBLE WASHER SET

Double washer set flange isolation kits include the following components for each bolt:

- Two - 1/8" thick steel washers
- Two - Isolating washers
- One - Full length isolating sleeve



## APPLICATION CONSIDERATIONS

Double washer configurations may be used for added protection against the possibility of "shorting out" the nuts and bolts. In addition, double washer sets electrically isolate the nuts and bolts from both flanges.

## SINGLE WASHER SET

Single washer set flange isolation kits include the following items for each bolt:

- One - 1/8" thick steel washer
- One - Isolating washer
- One - Isolating sleeve



## APPLICATION CONSIDERATIONS

In buried applications, single washer configurations may be used to allow the Cathodic Protection (CP) current to reach the nuts and bolts. If desired, nuts on the opposite side of the cathodically protected flange may be included as part of the CP system.

## G-10 ONE-PIECE SLEEVE AND WASHER SET

One-piece sleeve and washer set flange isolation kits include the following items for each bolt:

- One - 1/8" thick steel washer
- One - 1/8" thick G-10 Washer
- One - G-10 Isolating Sleeve



## APPLICATION CONSIDERATIONS

Easier to install, one-piece sleeves also allow the inspector a visual indication of sleeve usage.

## STEEL WASHERS

Steel washers are designed to fit over the isolating sleeve or the retainer ring on the one-piece sleeves and washers. The outside diameter is sized to fit within the bolt facing on ANSI standard flanges. They are made of 1/8" (3.2mm) thick plated hot-rolled steel. (Stainless steel available)

## Full length sleeve, double washer set configuration

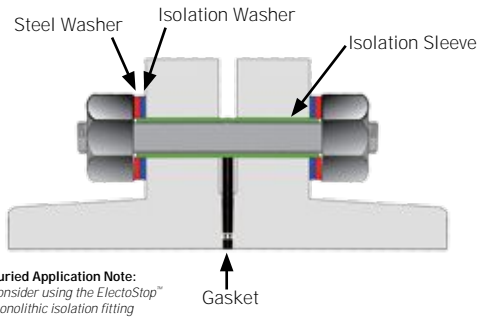

## 1/8" WASHER MATERIAL PHYSICAL PROPERTIES

ASTM Test Method		G-10 Epoxy/Glass	G-3
D149	Dielectric Strength Volts/Mil (Short Time)	800	550
D695	Compressive Strength psi	65,000	58,000
D229	Water Absorption %	0.04	0.08
	Operating Temp °F	Cryogenic to +302	Cryogenic to +392
	Operating Temp °C	Cryogenic to +150	Cryogenic to +200

## SLEEVE MATERIAL PHYSICAL PROPERTIES

ASTM Test Method		Mylar	G-10 Epoxy/Glass	Nomex®
D149	Dielectric Strength Volts/Mil (Short Time)	4000	800	550
D695	Compressive Strength psi	N/A	N/A	N/A
D229	Water Absorption %	0.8	0.04	0.08
	Operating Temp °F	-75 to +300	Cryogenic to +302	Cryogenic to +392
	Operating Temp °C	-59 to +149	Cryogenic to +150	Cryogenic to +200
D790	Flexural Strength psi	13,000	65,000	58,000
	Cut Through Resistance ft-lbs	3,500	16,000	No Test

Nomex is a registered trademark of DuPont

# GPT VCS Flange Isolation Ordering Guide/Worksheet

Quantity	Nominal Pipe Size	ANSI Class	Gasket Type	Gasket Style	For VCS		Washers	Washer Material	Sleeve	Gasket I.D. Schedule Pipe Flange	Type
Specify Below	Specify Below	150# 300# 400# 600# 900# 1500# 2500#	E = With Bolt Holes F = Ring (No Bolt Holes)	VCS	<u>Retainer</u> G-10 G-11	<u>Seal Element</u> FKM PTFE	DW = Double Washer	G-10 1 PC G-10 G-11	Mylar G-10 G-11	Specify Below	W = Weld Neck S = Slip On R = RTJ O = Other Denote Specs. & Table
Quantity	Nominal Pipe Size	ANSI Class	Gasket Type	Gasket Style	For VCS		Washers	Washer Material	Sleeve	Gasket I.D. Schedule Pipe Flange	Type

Retainer   Seal Element

**FOR FLANGE ISOLATION KITS OVER 24' IN ADDITION TO THE ABOVE PLEASE SPECIFY:**

Flange Facing (Raised, RTJ...etc)	_____	Nominal Bolt Diameter (Threads/Inch)	_____
Flange I.D.	_____	Sleeve Length	_____
Flange O.D.	_____	Pipe I.D.	_____
Flange Thickness	_____	Steel Sleeve I.D. (For Concrete Pipe)	_____
Number of Studs/Bolts	_____	Product in Line	_____
Stud/Bolt Diameter	_____	AWWA Class & Table (Or other similar std.)	_____
Stud/Bolt Hole Diameter	_____	Internal Lining	_____
Stud/Bolt Circle Diameter	_____		

**NOTE: Caution!** Bolts with smooth shank portions may not fit within sleeves. Verify prior to ordering.

**WARRANTY**

All products are warranted against failure caused by manufacturing defects for a period of one year. Any product found to be so defective and returned within one year from date of shipment will be replaced without charge.

The above warranty is made in lieu of, and we disclaim, any and all other warranties, expressed or implied, including the warranties of merchantability and fitness for a particular purpose, and buyer agrees to accept the products without any such warranties. We hereby disclaim any obligation or liability for consequential damages, labor costs or any other claims or liabilities of any kind whatsoever.



**Flange Faces >250 Micro Inches:**

For flange face surfacing greater than 250 micro inches, consult factory.



### GPT WATER JET AND CNC MACHINES

GPT's water jet machinery cut intricate parts with no heat-affected zone, distortion, or mechanical stresses caused by other cutting methods. In addition, they cut with a narrow kerf, to provide better usage of raw material. As a result GPT has the ability to provide more accurate gaskets, with more intricate shapes and possibilities without wasting raw materials. CNC machines cut precise dimensions to accommodate specific seal elements and gasket tolerances.

## Typical Specifications

### ALL CRITICAL SERVICE APPLICATIONS

Materials for sealing gaskets on pipes containing water, aqueous fluids, oil, sour or natural gas (up to 302°F, 150° C) consist of the following components:

### ISOLATION AND SEALING GASKET

One isolating and sealing gasket, VCS Type "F", 0.260" thick, 316 stainless steel core retainer laminated on both sides with a G-10 fiber glass reinforced laminate containing a precision tapered groove to accommodate the controlled compression of a PTFE spring energized seal. Sealing element placement shall accommodate either flat, raised or RTJ face flanges. The PTFE seal shall be spring and pressure energized. The G-10 retainer shall have a 800 volts/mil dielectric strength and a minimum 69,000 psi compressive strength. The I.D. of the flange isolating gasket shall matches the bore of the flange in which it is installed.

### QUALITY

Isolation Kits are manufactured at a GPT facility that has a registered ISO 9001:2008 Quality Management System. Submittals shall include copy of valid registration. Performance suitability and material compatibility shall be determined by the user.

### AVAILABILITY

Isolation Kits manufactured by:  
 GPT, Denver, CO, U.S.A.,  
 Telephone: 303-988-1242, Facsimile: 303-988-1922,  
 www.gptindustries.com e-mail: info@gpt.com

## Extreme Critical Sealing for Industries

### PRODUCTION FIELDS AND OFFSHORE

In gathering and injection piping, tank farms, oil and gas processing systems, and sour gas and water handling systems. Christmas trees, pumps, valves, and wherever it is important to guard against the loss of product.

### PETROLEUM MARKETING FACILITIES

In terminal and tank farm piping, marine and airport fueling systems and other product handling facilities where it is essential to prevent loss of product or damage due to a flange leak or blowout.

### LNG AND SNG SYSTEMS

For loading, unloading, liquefaction, regasification and processing of LNG, the production and processing of SNG, and wherever it is essential to provide a leak-proof flange for use from cryogenic to very high temperatures.

### PIPELINE AND DISTRIBUTION PIPING

In compressor and pumping station piping, metering and measurement facilities, valves and other control equipment and elsewhere on a mainline piping system where a long-lasting, leak-proof flange is essential. In gas distribution piping - underground storage facilities, town border stations, industrial meter, regulator sets, and district regulators.

### REFINERIES

In piping systems for heavy gasoline, caustic and acid based materials, carbon slurry, and wherever it is essential to protect plant and personnel from damage due to flange leaks or blowouts.



GPT 1:6



4990 Iris St., Wheat Ridge, CO 80033  
 Tel: (303) 988-1242 Fax: (303) 988-1922  
 www.gptindustries.com

6455 Clara Road, Suite 300, Houston, TX 77041  
 Tel: (713) 747-6948 Fax: (713) 747-6029  
 www.gptindustries.com

Unit 3-5, Chester Road, Colmworth Business Park  
 Eaton Socon, St. Neots, Cambridgeshire, PE 19 8YT  
 Tel: +44 (0) 1480 404661 Fax: +44 (0) 1480 404662  
 www.gptindustries.com